



Cassette awning

## markilux 970

Aesthetics and technology perfectly united –  
the compact cassette awning in a timeless, purist design.



[markilux.com](http://markilux.com)

**markilux**  
safe timeless beautiful

# Product Characteristics

Wind resistance class 2  
Beaufort 5 → 7.5–10.4 m/s → 28–37 km/h → 17–23 mph

01  
02  
03  
04  
05  
06  
07  
08  
09

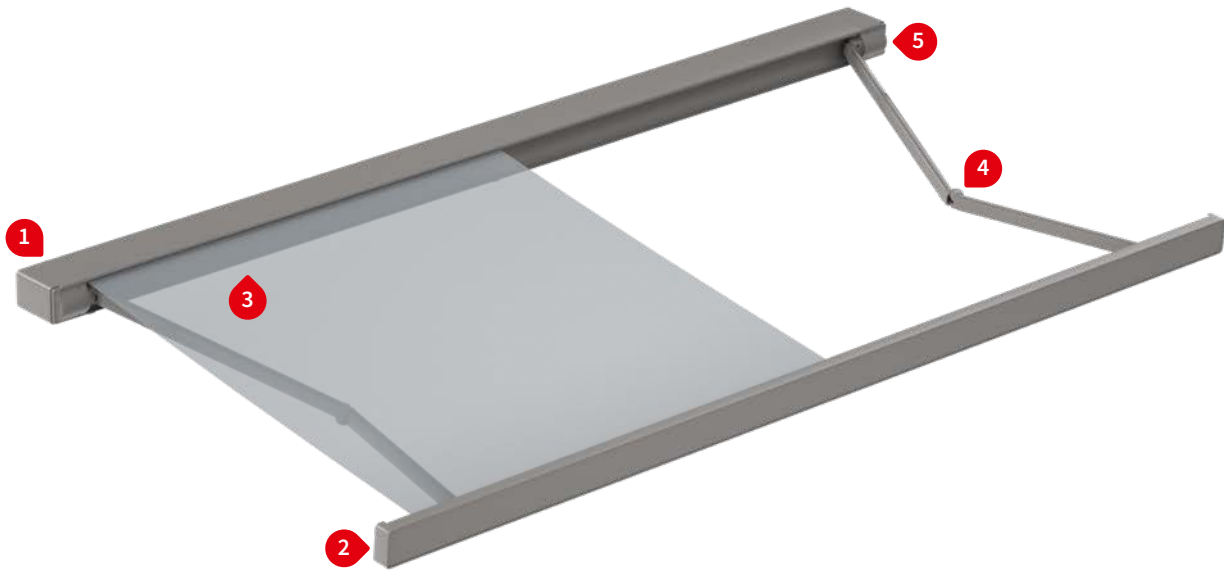

10  
11  
12  
13  
14  
15  
16  
17

1 face fixture, maximum pitch of 30°



1 top fixture



1 top fixture, view from the rear and below



2 shadeplus<sup>1)</sup>



4 bionic tendon made of high-tech fibres for optimum power transference



3 LED-Line in the cassette<sup>1)</sup>

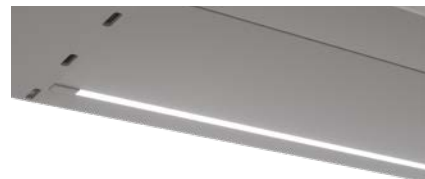

3 LED-Spots underneath the cassette<sup>1)</sup>



2 shadeplus, during extension<sup>1)</sup>

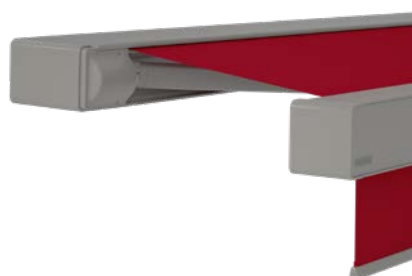

5 arm bearer with tilt device technology, integrated windlock mechanism



1) Optional accessories

## Product Characteristics

### Description

- angular cassette awning built in an unobtrusive style, with ingenious accessory options and unique fixture technology

### Special features

- option of shadeplus up to a projection of 300 cm – vertical protection against low-lying sun and inquisitive glances integrated into the front profile, can be operated by radio remote control
- option of directional LED Line fitted to the underside of the cassette which provides an appealing atmosphere in the evening
- various screen profile and awning colours can be combined
- the special cassette profile surrounds the roller tube even when the awning is extended and lends the awning a harmonious, closed appearance
- the straight lines with smooth front panel suit a minimalistic building style perfectly
- the design characteristics allow the awning to be fitted into niches and reveals
- the virtually invisible face and top fixture brackets mean the awning cassette fits flat against the building
- the tilt device technology with integrated windlock mechanism functioning as arm bearers ensures the awning closes cleanly regardless of the pre-set pitch

### Dimensions

- cassette in the standard version: depth 266 mm, height 140 mm
- single unit: minimum width 195 cm at the smallest projection of 150 cm, maximum width 500 cm at the largest projection of 350 cm or 600 cm at a maximum projection of 300 cm

### roller tube and lateral bearings

- round roller tube Ø 85 mm with keyway, galvanised steel – excellent stability, ensures near perfect cover performance even at the largest widths
- the cassette side cap is made of die-cast aluminium, powder coated

### Awning profiles

- extruded aluminium, in façade quality, powder coated
- two-piece cassette with clever inner profile – providing the awning cover with optimum protection against the elements
- angular front profile with integrated rain gutter and a smooth front panel

### Folding arms

- profiles in extruded aluminium, in façade quality, powder coated
- moving parts made of drop-forged aluminium – the arms are therefore extremely fracture resistant
- pivot bolts in stainless steel run in Teflon-coated bronze bushes - practically maintenance free, virtually silent and extremely hard wearing
- power transference via the innovative bionic tendon at the elbow joint, made of high tensile, high-tech fibres low in friction, noiseless, insensitive to corrosion and UV resistant

### End caps

- the cassette end caps are made of high-quality plastic, powder coated
- the internal caps to cover the internal arm bearers at the side are made of die-cast aluminium
- the front profile end caps are made of die-cast aluminium, powder coated, with water drainage holes

### Fixture brackets

- face fixture, top fixture, eaves fixture
- extruded aluminium, powder coated
- awning pitch adjustment range 5° to 30°
- spacer plates, stand-off brackets and other accessories are available

01 **Frame and end cap colours**

markilux frame colours without surcharge

02 traffic white, RAL 9016

metallic aluminium, RAL 9006

grey brown, similar to RAL 8019



06 off-white textured finish, 5233 <sup>1)</sup>

stone grey metallic, 5215 <sup>1)</sup>

anthracite metallic, 5204 <sup>1)</sup>



**09**

10 havana brown textured finish, 5229 <sup>1)</sup>



**Non-standard powder-coated finish**

14 Bespoke frame colours incur a surcharge – matt, metallic, finely textured and pearl finishes as well as other colour ranges (DB, Tiger etc.) on request. All frame colours are available at a surcharge with enhanced corrosion protection.

15 Colours may differ slightly from those depicted in both hue and finish.

16 **1)** textured finish

17 **Combination options**

All standard styling panel colours can be combined at will with the standard frame colours <sup>2)</sup>

**Frame** stone grey metallic, 5215  
**Front panel** anthracite metallic, 5204

**Frame** off-white textured finish, 5233  
**Front panel** anthracite metallic, 5204

**Frame** traffic white, RAL 9016  
**Front panel** metallic aluminium, RAL 9006



**Frame** anthracite metallic, 5204  
**Front panel** stone grey metallic, 5215



**2)** Illustrations by way of example; colours may differ slightly from those depicted in both hue and finish.



### Additional front panel colours

The additional styling panel colours can be combined at will with all the standard frame colours <sup>1)</sup>

01

02

03

04

05

06

07

08

**09**

10

11

12

13

14

15

16

17



**Front panel** Anodised light bronze 1/C-0  
**Frame** Stone grey metallic, 5215  
**Awning cover** 314 25



**Front panel** Anodised light bronze 1/C-32  
**Frame** Havana brown textured finish, 5229  
**Awning cover** 309 07



**Front panel** Anodised light bronze 1/C-35  
**Frame** anthracite metallic, 5204  
**Awning cover** 315 97

Colours may differ slightly from those depicted in both hue and finish.

1) Illustrations by way of example; fabric pattern with matching front panel.

01	<b>Optional accessories</b>
	drop valance, manual or motor operation
02	LED-Line in the cassette
	LED-Spots underneath the cassette
03	infrared heater 2500 W
04	infrared heater 2500 W with integrated radio-controlled receiver 868 MHz io
	automatic controls (light, wind, rain)

N.B. Important background information can be found in the chapter "Optional Accessories"

	<b>Fixture options</b>	
	face fixture bracket left, 100 mm	72826.
	face fixture bracket right, 100 mm	72827.
	fixture plate A 430 × 160 × 12 mm	72870.
	fixture plate B 300 × 400 × 12 mm	75325.
	fixture plate C 310 × 130 × 12 mm	72526.
	markilux panel 250 × 230 × 49 mm	76308.
	markilux panel continuous	701104

	stand-off bracket 80–300 mm	72872.
--	-----------------------------	--------

	top fixture bracket left 90 mm	72860.
--	--------------------------------	--------

	top fixture bracket right 90 mm	72861.
--	---------------------------------	--------

	eaves fixture bracket left 90 mm, 150 mm top plate	72874.
--	---	--------

	eaves fixture bracket right, 90 mm, 150 mm top plate	72875.
--	---	--------

	eaves fixture bracket 90 mm, plate 270 mm	71659.
--	---	--------

	flat plate and angled bracket for eaves fixture, machine finish aluminium, 500 mm	716620
--	--	--------

	spreader plate 260 × 60 × 12 mm, for eaves fixture bracket 90 mm	75383.
--	---	--------

09

10

11

12

13

14



15

16

17

## Dimensions and configuration options

### Single unit

		Awning width								Minimum width	
		250	300	350	400	450	500	550	600	Motor	Crank handle
<b>Order dimensions</b>		195	251	301	351	401	451	501	551		
		250	300	350	400	450	500	550	600		
<b>H</b>	150	1)								195	195
	200	1)								245	245
	250	—	1)							295	295
	300	—	—	1)				2)	2)	345	345
	350	—	—	—	1) 2)	2)	2)	—	—	395	395

dimensions in cm

1) = please note the minimum widths!

2) = drop valance not available

H = projection

 = 2 folding arms,  
2 brackets

 = 2 standard arms

### Operation

	standard	optional
crank handle	✓	—
spring-assisted crank handle	—	✓
hard-wired motor	—	✓
silentec motor (optionally with an external io / RTS receiver)	—	—
radio-controlled motor io, 868 MHz	—	✓
433 MHz Funkmotor RTS	—	✓
868 MHz radio-controlled motor io, with manual override	—	—

### Coupled awnings

not available

Awning cover	fabric pattern no.	standard	optional
sunvas	300.. - 315..	✓	—
sunsilk	324.. / 328.. / 369..	✓	—
sunbow <sup>1)</sup>	411.. - 427..	✓	—
smart art	340..	—	✓
perla FR	371.. / 372..	—	✓

1) up to max. 300 cm projection available

### Drop valance<sup>1) 2)</sup>

	standard	optional
height 170 cm		
maximum projection 300 cm <sup>3)</sup>		
crank handle	✓	—
hard-wired motor	—	✓
radio-controlled motor io, 868MHz	—	✓
radio-controlled motor RTS, 433MHz	—	✓
fabric pattern sunvas / sunsilk / sunbow / transolair / vuscreen Alu / Serge 600		

1) a shadeplus is impractical for fixture in a top well and in a reveal if top or eaves fixture is used

2) the seams in covers made from fabrics 120 cm wide run across the awning. As a result, a fabric with a textured or flecked pattern will take on an appearance different from that of the awning cover if made from the same fabric.

3) olding arms in a taller version (with cable conduits); Not available in the dimensions [501–600] × 300 cm

## Lighting options

### LED-Line in the cassette

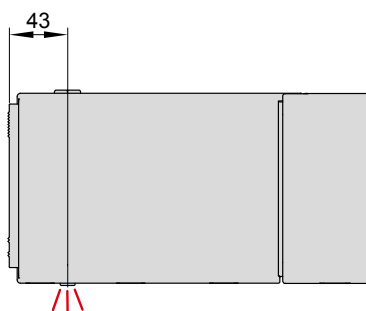

dimensions in mm

### Technical specification

operating voltage	230 V, 50 Hz
power output per metre	10 W / metre
number of LEDs per metre	120 LEDs / metre
light source	LED (12 V)
number of transformers	1 unit
light temperature	warm white
IP protection class	IP 44
service life	approx. 15.000 h

### Controls

	standard	optional
radio-controlled dimmer io 868 MHz	✓	—
radio-controlled dimmer RTS 433 MHz	✓	—

### Electrical connection

power supply cable H05RN-F 3G1 (3 × 1 mm <sup>2</sup> ) with open end
--



# Lighting options

Directional LED spotlights underneath the cassette

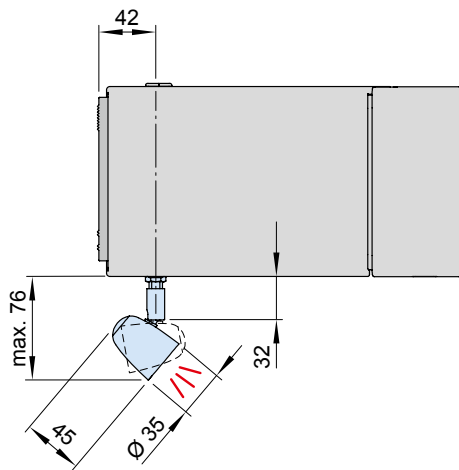

dimensions in mm

### Technical specification

operating voltage	230 V, 50 Hz
power output of one LED spotlight	5 W
light source	LED (12 V)
number of transformers	1 unit
light temperature	warm white
IP protection class	IP 44
service life	approx. 20.000 h

### Controls

	standard	optional
radio-controlled dimmer io 868 MHz	✓	—
radio-controlled dimmer RTS 433 MHz	✓	—

### Electrical connection

power supply cable	H05RN-F 3G1 (3 × 1 mm <sup>2</sup> ) with open end
--------------------	--

LED spotlight distribution underneath the cassette

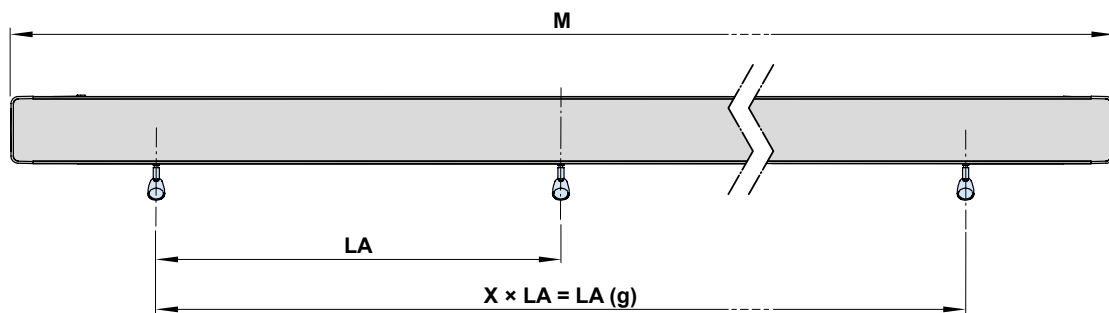

Awning width	No. of spotlights	LA	LA (g)
195–250	3	75	150
251–300	3	98	196
301–350	3	98	196
351–400	4	98	294
401–450	4	98	294
451–500	5	98	392
501–550	5	98	392
551–600	6	98	490

dimensions in cm

LA (g) = distance between the spotlights (total)  
 M = order dimension = awning width

01 **Bracket fixture range**

02 Face fixture

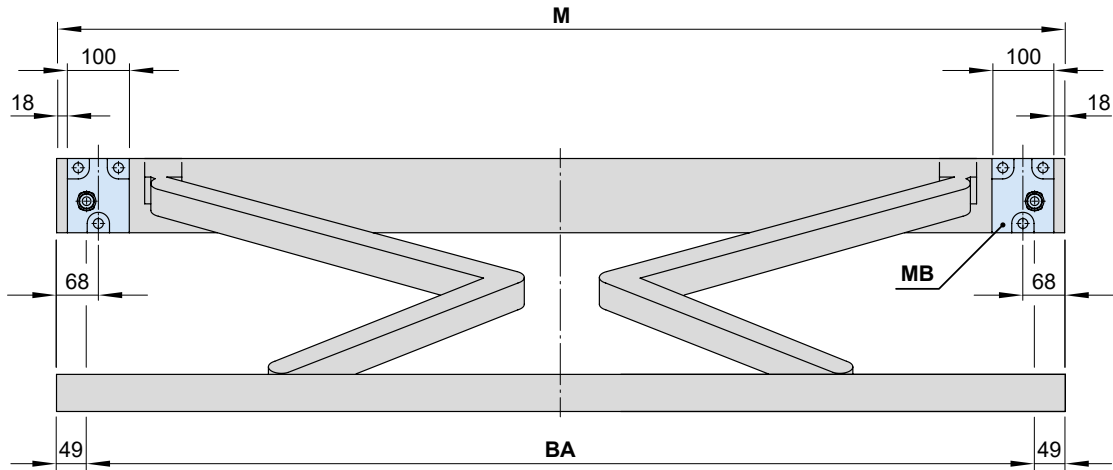

09

10 Top fixture

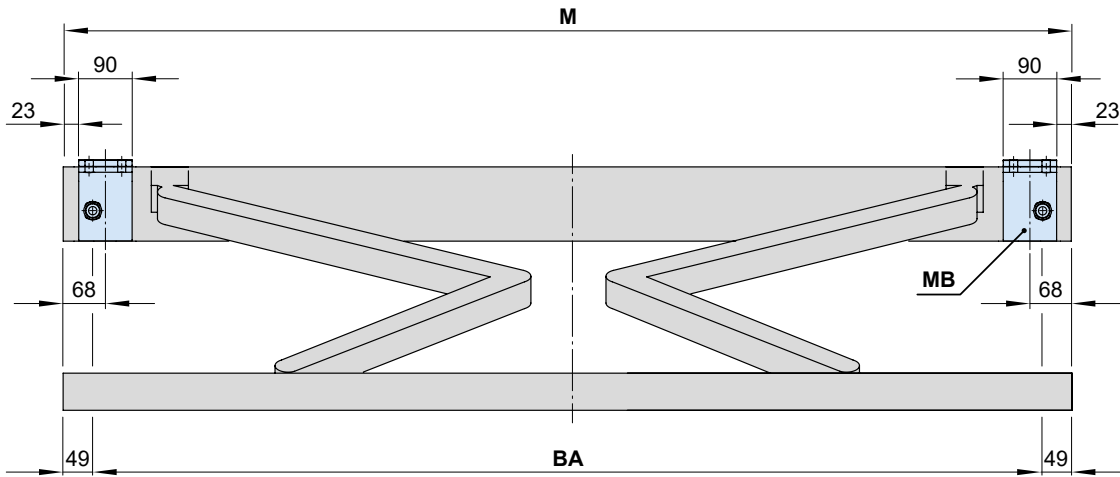

17 Eaves fixture

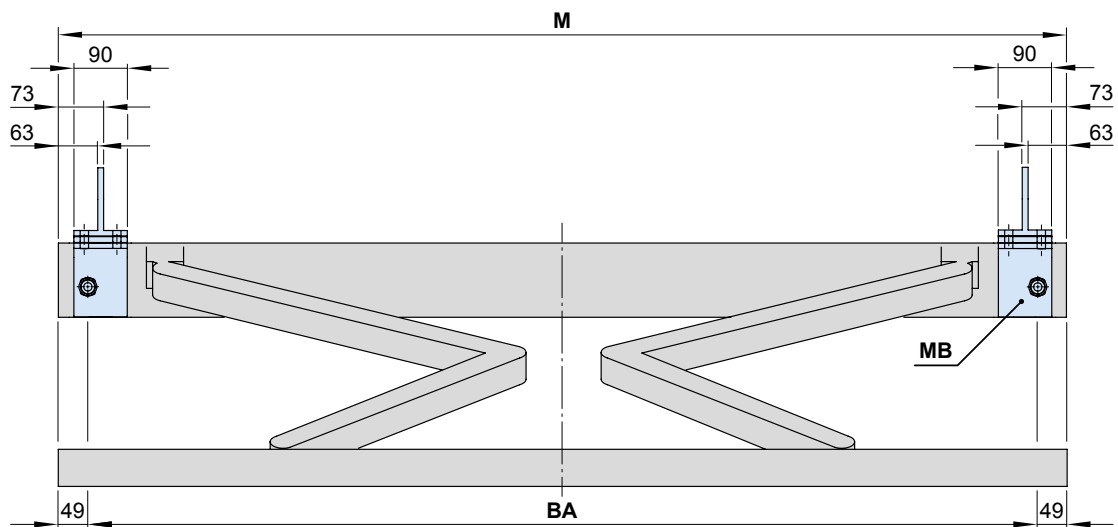

- BA = width between fixture points
- MB = bracket fixture range
- M = **order width** = awning width

dimensions in mm

## No. of brackets | No. of fixing points

		Awning width							
		250	300	350	400	450	500	550	600
Order dimensions		195	251	301	351	401	451	501	551
		250	300	350	400	450	500	550	600
		No. of brackets   No. of fixing points							
<b>W</b>	<b>BHT 10</b>	2   6							
<b>BP</b>		A 2   16			B 2   8		C 2   12		
<b>PA</b>		2   8							
<b>DA / DE</b>	<b>9</b>	2   8							

dimensions in cm

**N.B!** If awnings are installed directly next to one another, a minimum distance of 50 mm must be maintained between each awning!

The **pull-out forces** necessary for determining the correct fixing materials necessary to meet wind resistance class 2 (Beaufort 5) can be found in the password-protected dealer area of the [pro.markilux.com](http://pro.markilux.com) website under "Pull-out Forces".

- BHT** = bracket width
- BP** = spreader plate **A** or **B**, to be positioned behind the folding arm
- DA** = eaves fixture brackets
- DE** = top fixture brackets
- PA** = markilux panel, fixture profile, width 250 mm
- W** = face fixture brackets

# Face fixture

## Fixtures, fittings and accessories

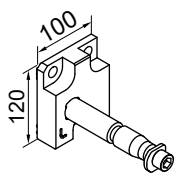

face fixture bracket left

72826.

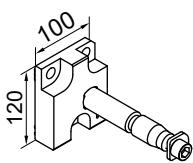

face fixture bracket right

72827.

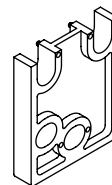

spacer plate for face fixture  
100 × 120 × 20 mm

**N.B!**  
Stack to a max. height of 200 mm

718581

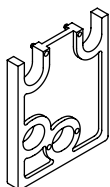

spacer plate for face fixture  
100 × 120 × 12 mm

718571

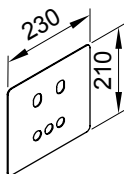

cover plate for spacer plate and stand-off brackets in the case of external insulation  
230 × 210 × 2 mm

71843.

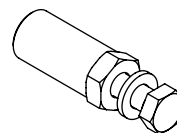

reduction bolt  
M 16 → M 12 / SW 27

50 mm

753891

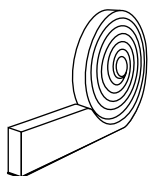

compression tape  
PU soft foam material to eliminate gaps, in rolls of 15 m, gap size from 3–7 mm, with a minimum resistance to water ingress of 600 Pa, grey

795721

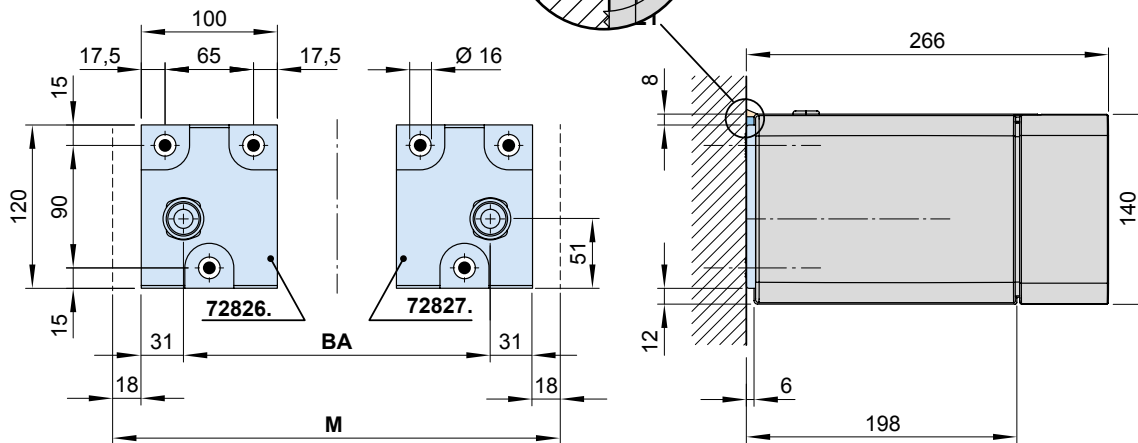
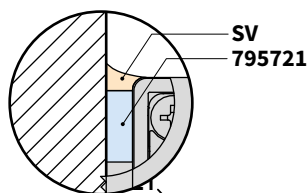

- 795721 = compression tape (optional)
- BA = width between fixture points
- M = **order dimension** = awning width
- SV = silicon seal

dimensions in mm

# Face fixture with spreader plate A

Fixtures, fittings and accessories

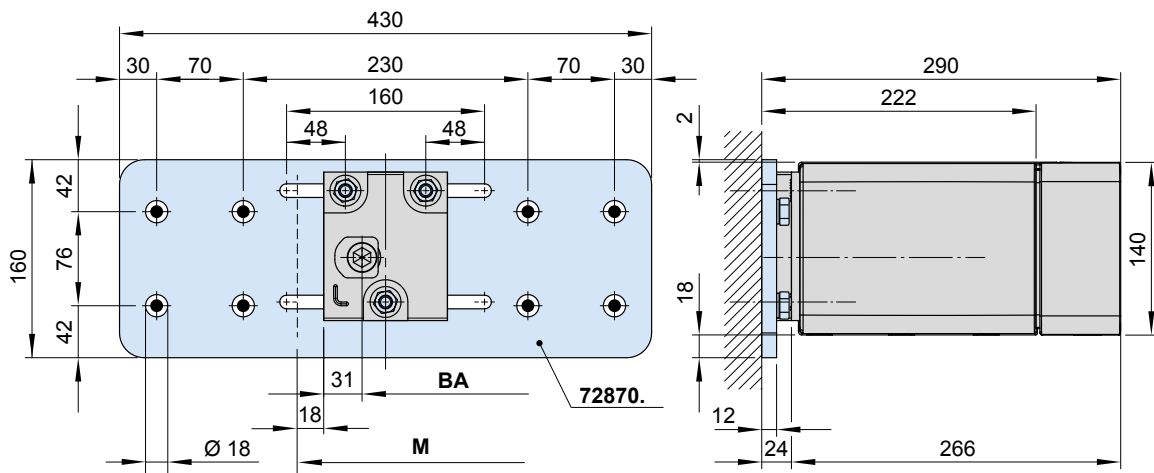
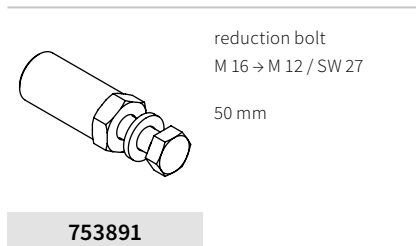
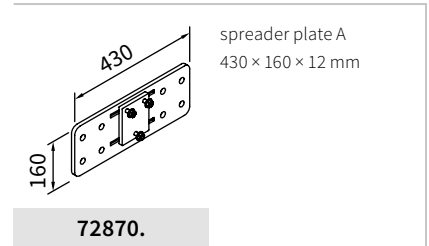
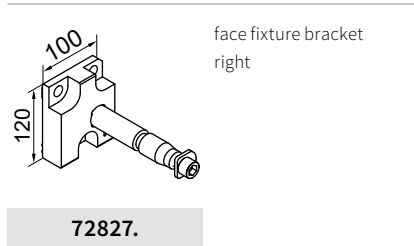
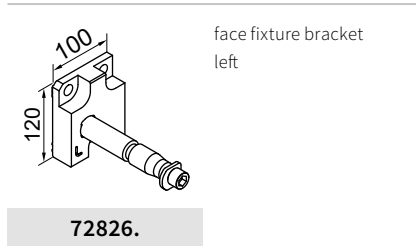

BA = width between fixture points  
M = **order dimension** = awning width

dimensions in mm

01  
02  
03  
04  
05  
06  
07  
08  
**09**  
10  
11  
12  
13  
14  
15  
16  
17

01 **Face fixture with spreader plate B**

02 Fixtures, fittings and accessories

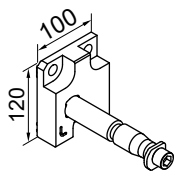

face fixture bracket left

05 **72826.**

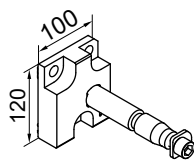

face fixture bracket right

05 **72827.**

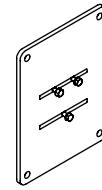

spreader plate B  
300 × 400 × 12 mm

05 **73465.**

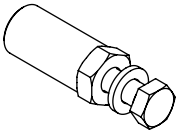

reduction bolt  
M 16 → M 12 / SW 27  
50 mm

09 **753891**

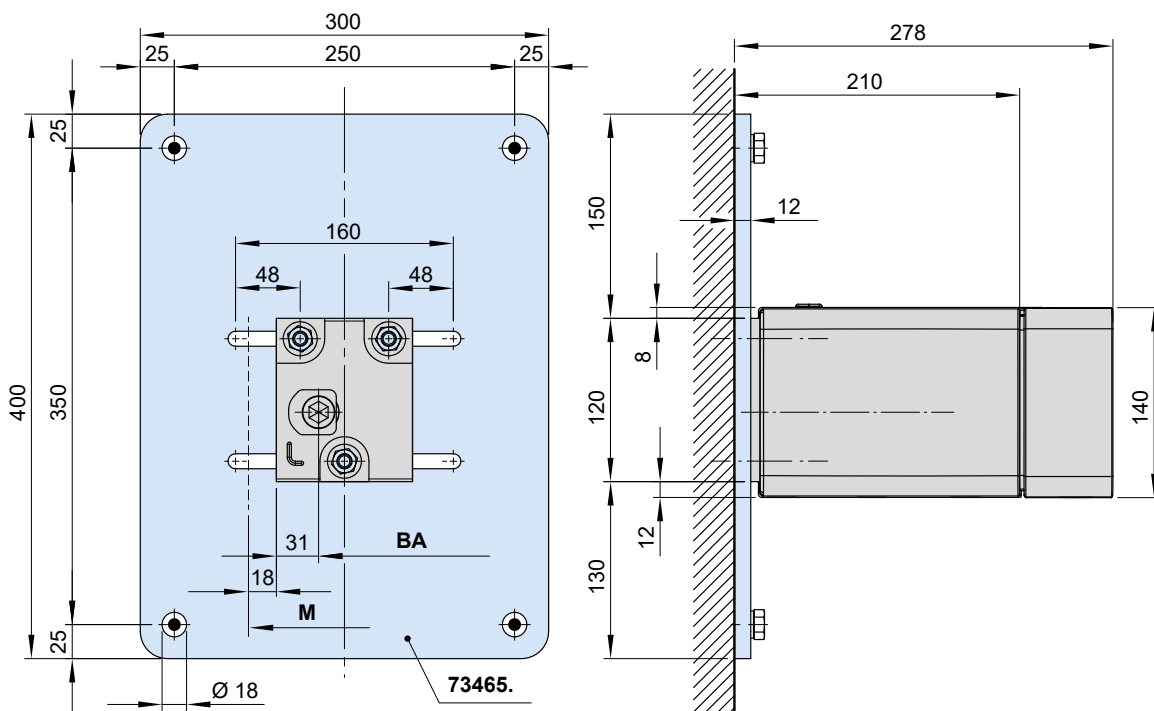

BA = width between fixture points  
M = **order width** = awning width

dimensions in mm



# Face fixture with spreader plate C

Fixtures, fittings and accessories

face fixture bracket left

**72826.**

face fixture bracket right

**72827.**

spreader plate C  
310 × 130 × 12 mm

**72526.**

reduction bolt  
M 16 → M 12 / SW 27  
50 mm

**753891**

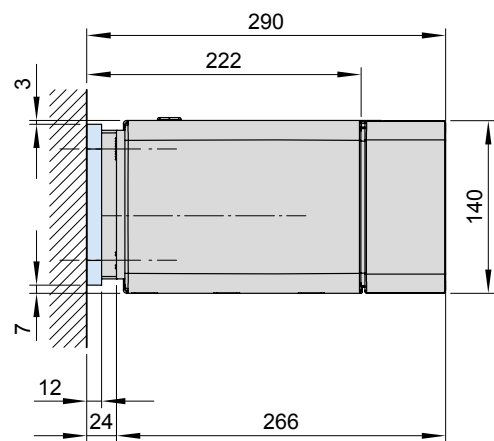
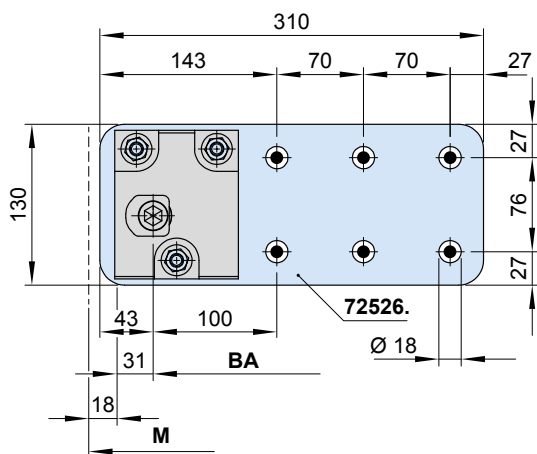

BA = width between fixture points  
M = **order width** = awning width

dimensions in mm

01  
02  
03  
04  
05  
06  
07  
08  
**09**  
10  
11  
12  
13  
14  
15  
16  
17

01 **Face fixture using the markilux panel 250 mm wide**

02 Fixtures, fittings and accessories

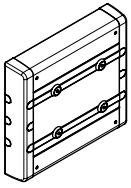

04 markilux panel  
250 × 230 × 49 mm  
with decorative profiles  
and end caps

05 **76308.**

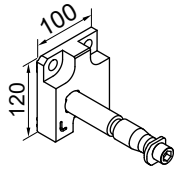

07 face fixture bracket  
left

08 **72826.**

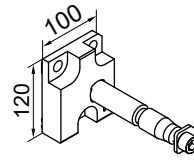

10 face fixture bracket  
right

11 **72827.**

**09**

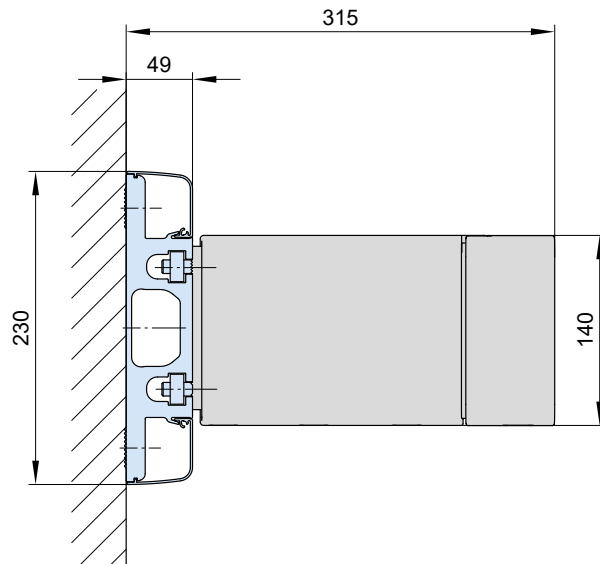
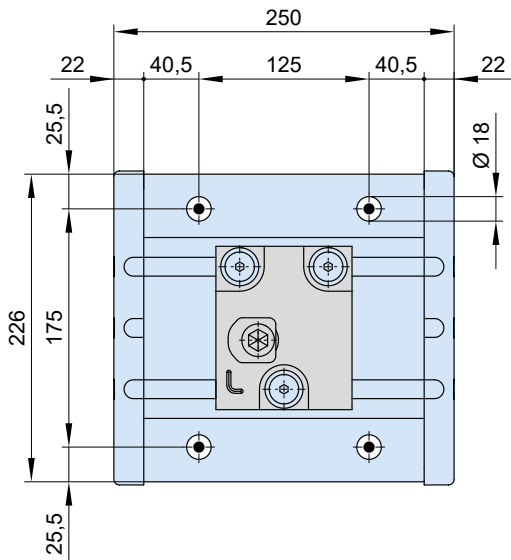

dimensions in mm

# Face fixture with markilux panel continuous

Fixtures, fittings and accessories

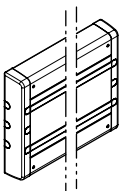

markilux panel continuous  
with decorative profiles and end caps

**701104**

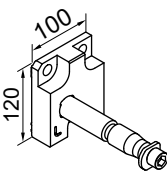

face fixture bracket left

**72826.**

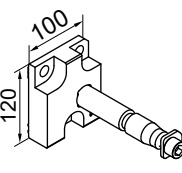

face fixture bracket right

**72827.**

As a **continuous fixture profile** the markilux panel will always be supplied to order on the basis of a technical drawing prepared in the factory in accordance with the awning specification.

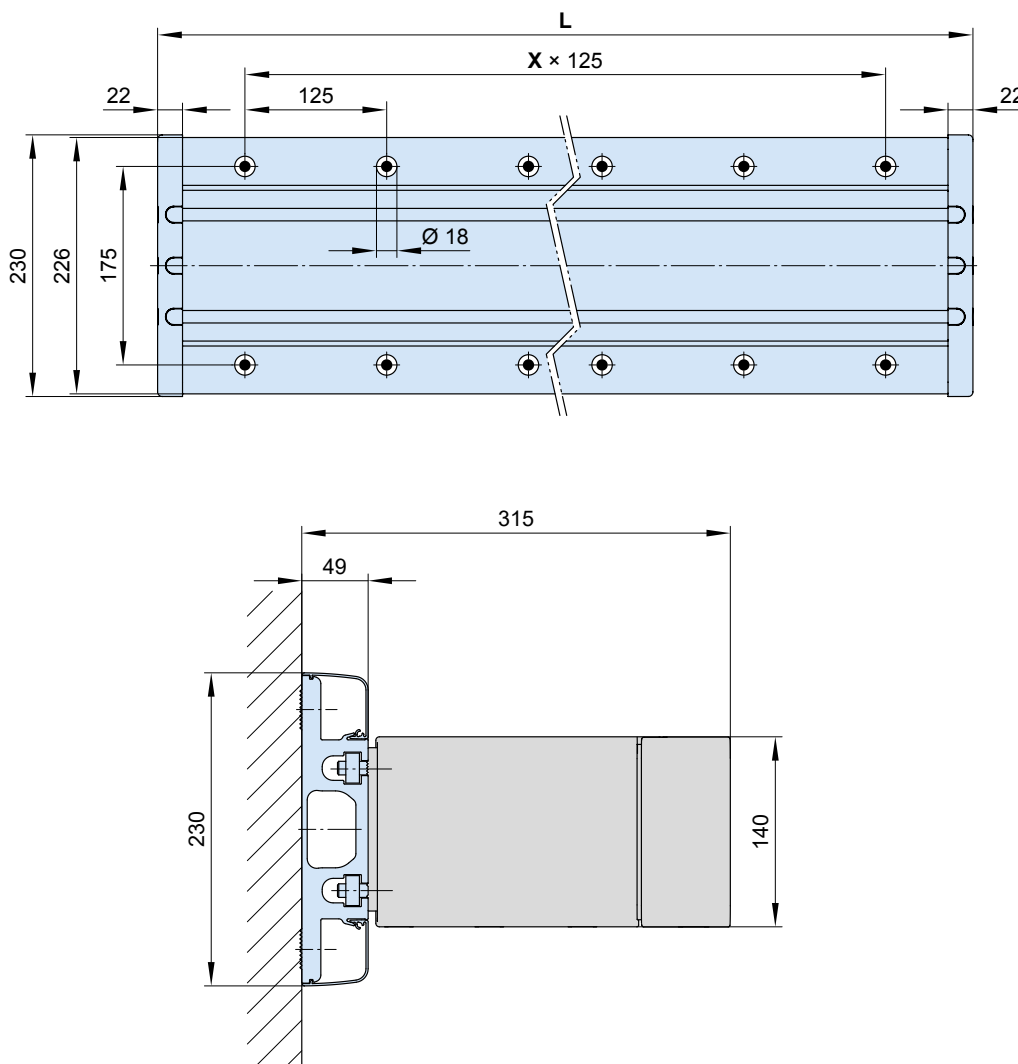

- L = individual width, max. 7000 mm
- x = fixing point separation, **by way of example**

dimensions in mm

# Face fixture with stand-off bracket

## Fixtures, fittings and accessories

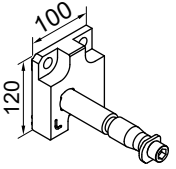

face fixture bracket left

72826.

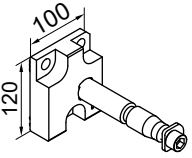

face fixture bracket right

72827.

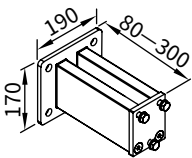

stand-off bracket  
80–300 mm  
for face fixture  
bracket 100 mm  
incl. insulating element

72872.

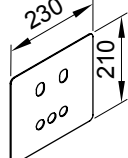

cover plate for spacer  
plate and stand-off  
brackets in the case of  
external insulation  
230 × 210 × 2 mm

71843.

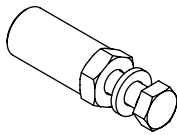

reduction bolt  
M 16 → M 12 / SW 27  
50 mm

753891



compression tape  
PU soft foam material  
to eliminate gaps, in  
rolls of 15 m, gap size  
from 3–7 mm, with a  
minimum resistance to  
water ingress of 600  
Pa, grey

795721

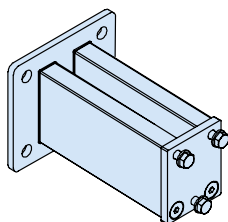

The aluminium stand-off bracket can be shortened on site from 300 mm down to 80 mm. But, then the M 12 threads must be retapped in the shortened profiles.

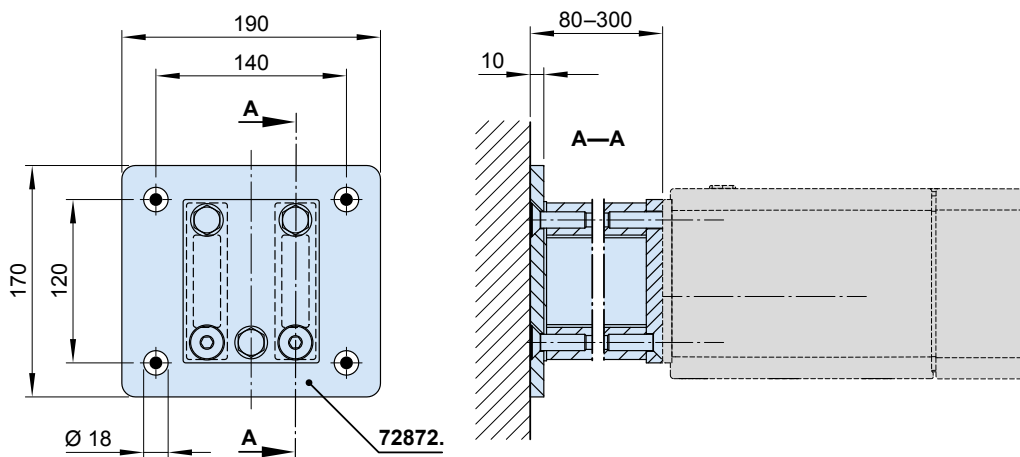

dimensions in mm

# Top fixture

## Fixtures, fittings and accessories

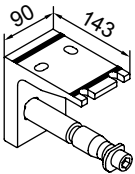

top fixture bracket left

**72860.**

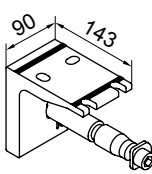

top fixture bracket right

**72861.**

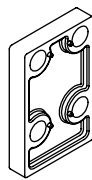

spacer plate for top fixture  
90 × 140 × 20 mm

**N.B!**  
Stack to a max. height of 200 mm

**716311**

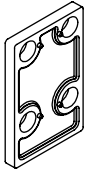

spacer plate for top fixture  
90 × 140 × 12 mm

**716411**

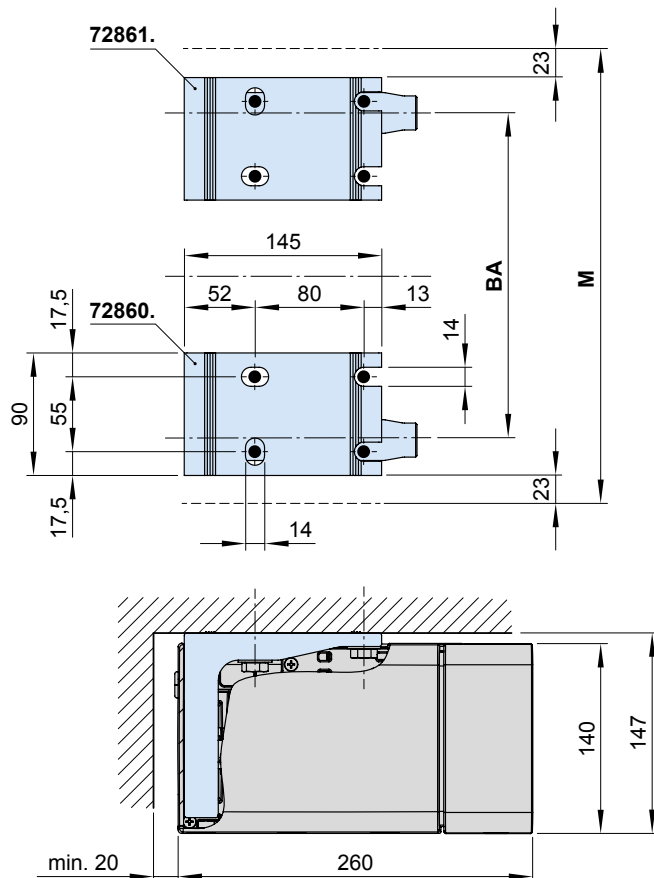

BA = width between fixture points  
M = **order width** = awning width

dimensions in mm

01  
02  
03  
04  
05  
06  
07  
08  
**09**  
10  
11  
12  
13  
14  
15  
16  
17

01 **Eaves fixture**

02 **Fixtures, fittings and accessories**

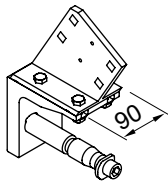

eaves fixture bracket left  
height of flat plate 150 mm

03 **72874.**

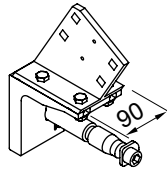

eaves fixture bracket right  
height of flat plate 150 mm

04 **72875.**

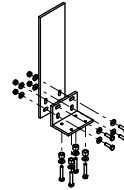

angle and plate for eaves fixture  
height of plate 500 mm  
machine finish

05 **716620**

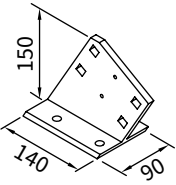

eaves fixture bracket 90 mm  
height of flat plate 150 mm

06 **71612.**

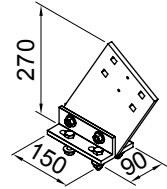

eaves fixture bracket 90 mm  
height of flat plate 270 mm

07 **71659.**



accessories for two eaves fixture brackets 71612.

08 **799601**

09

10 **With eaves fixture bracket 150 mm (71612.)**

11 **With eaves fixture bracket 270 mm (71659.)**

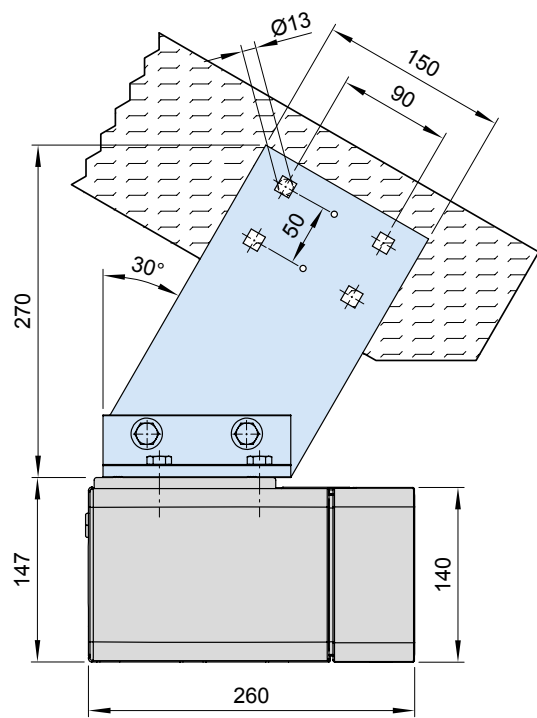
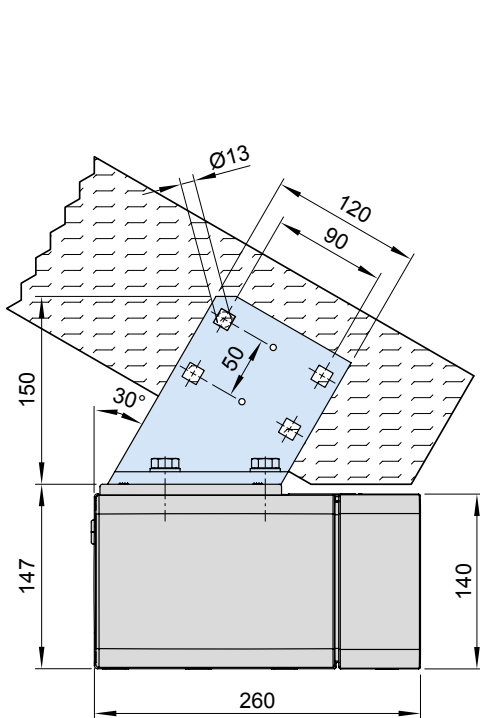

dimensions in mm



# Eaves fixture with additional plate

Fixtures, fittings and accessories

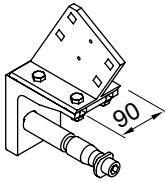

eaves fixture bracket left  
height of flat plate 150 mm

**72874.**

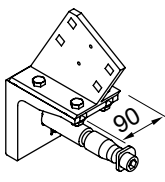

eaves fixture bracket right  
height of flat plate 150 mm

**72875.**

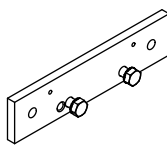

supplementary flat plate for eaves fixture  
260 × 60 × 12 mm

**75383.**

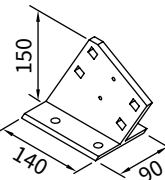

eaves fixture bracket 90 mm  
height of flat plate 150 mm

**71612.**

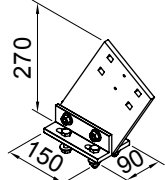

eaves fixture bracket 90 mm  
height of flat plate 270 mm

**71659.**

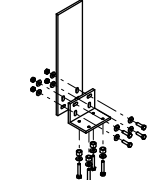

angle and plate for eaves fixture  
height of plate 500 mm  
machine finish

**716620**



accessories for two eaves fixture brackets 71612.

**799601**

With eaves fixture bracket 150 mm (71612.)

With eaves fixture bracket 270 mm (71659.)

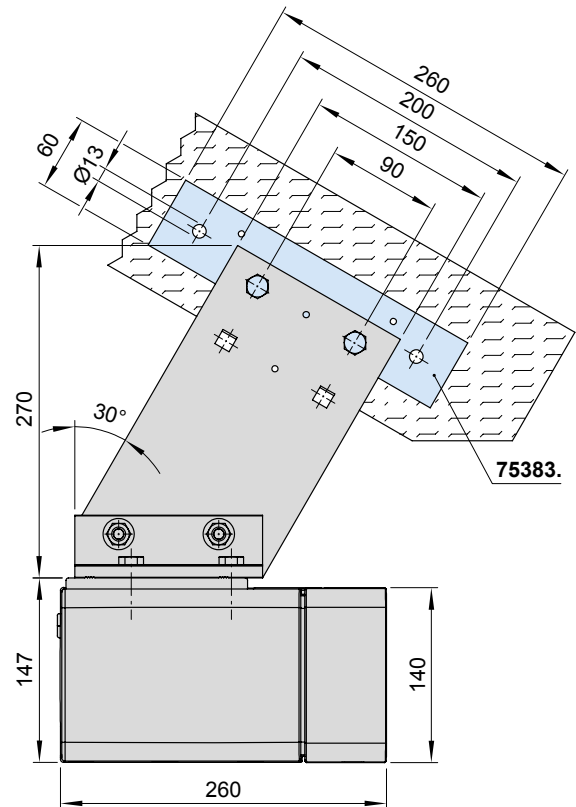
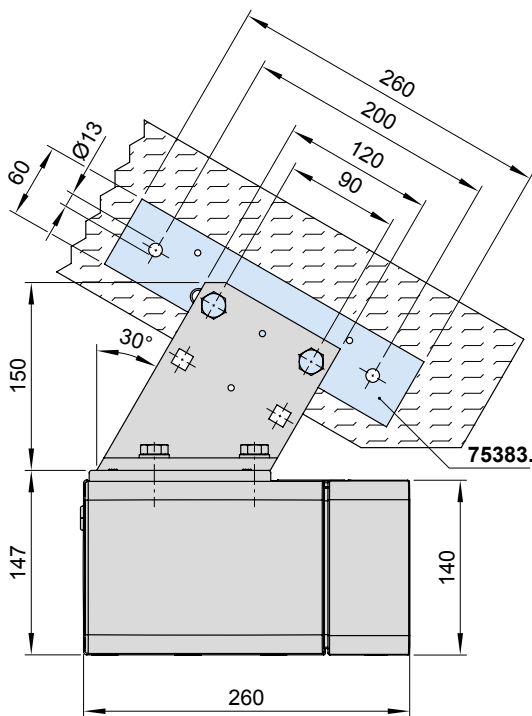

dimensions in mm

01  
02  
03  
04  
05  
06  
07  
08  
09  
10  
11  
12  
13  
14  
15  
16  
17



# Reveal fixture

Motor drive

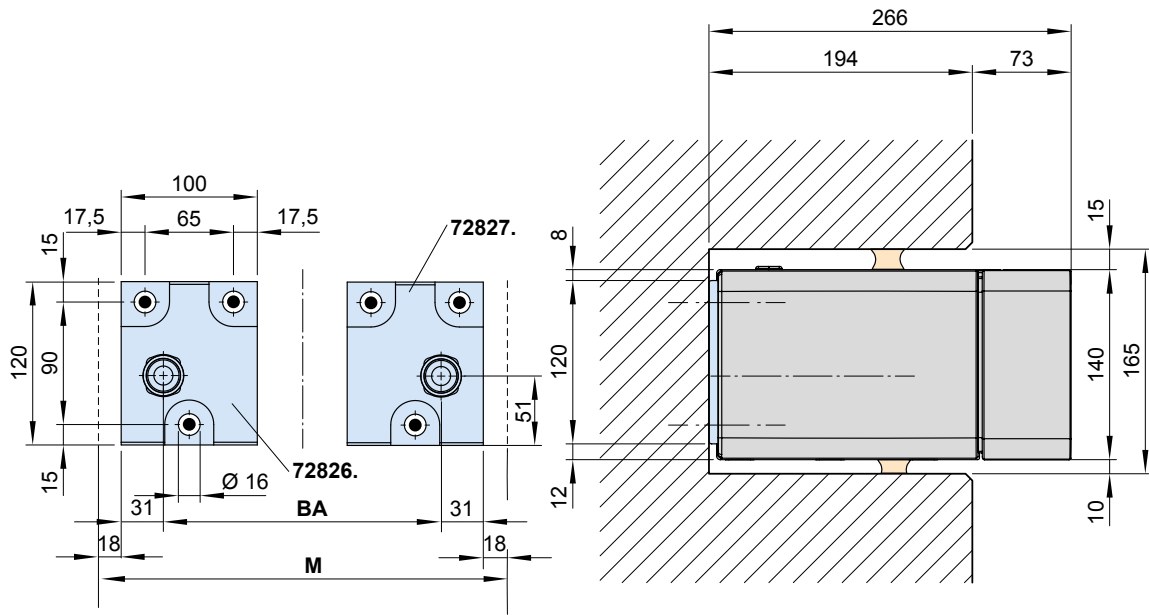

Installation flush with the fascia, without shadeplus

Installation flush with the fascia, with shadeplus

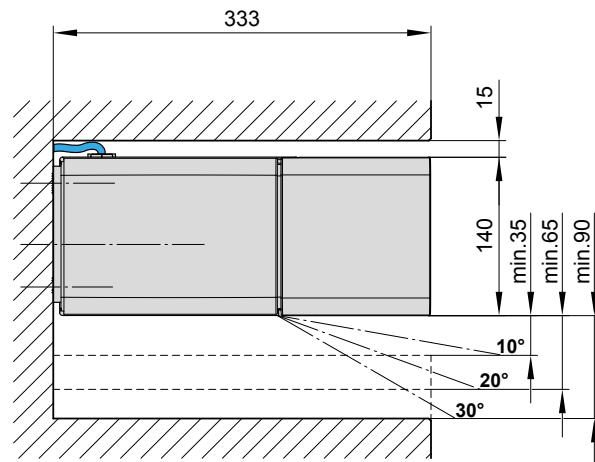
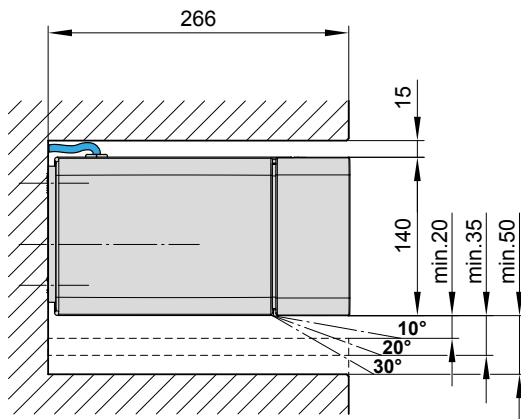

- 72826. = face fixture bracket, left
- 72827. = face fixture bracket, right
- BA = width between fixture points
- M = **order width** = awning width

dimensions in mm

01  
02  
03  
04  
05  
06  
07  
08  
**09**  
10  
11  
12  
13  
14  
15  
16  
17

01 Face fixture, manual operation <sup>1)</sup>

02

03

04

05

06

07

08

09

10

11

12

13

14

15

16

17

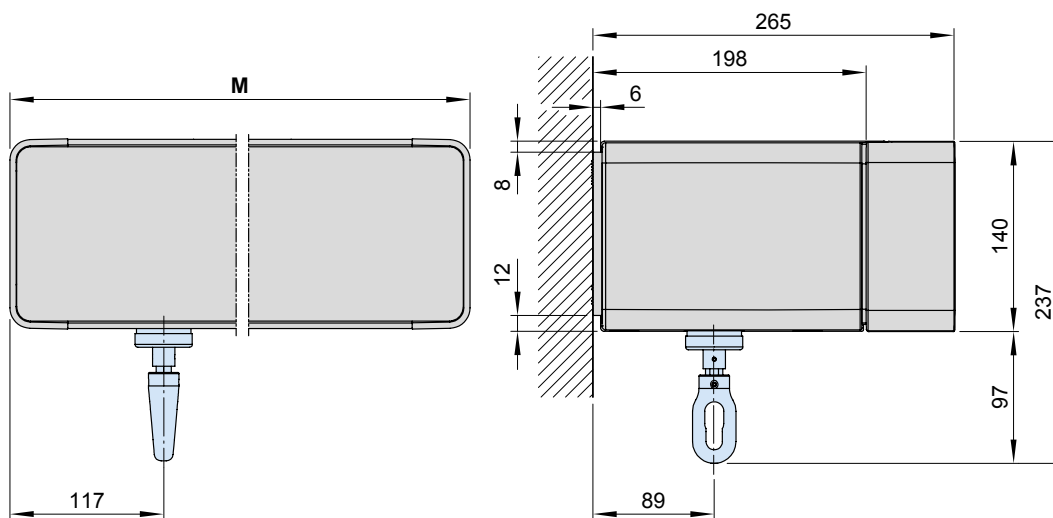

1) depending on the operation side, left or right  
**M** = **order width** = awning width

dimensions in mm



01

02

03

04

05

06

07

08

**09**

10

11

12

13

14

15

16

17